

Survey of Available GENI Resources

Aaron Falk
GENI Project Office
15 March 2011

- Introduction
- Resources
 - Compute & Programmable Systems
 - Wireless
 - Networks
 - Tools
- Getting access
- Wrap-up

- GENI has a diverse, rapidly growing set of resources – mostly prototypes – available for experimenter use
 - Compute resources: VM, hosts, cloud
 - Network resources: programmable switches, routers, & wireless

A GENI ‘slice’ can interconnect any of them using a range of connectivity options

- These are early days with limited or inconsistent...
 - Availability, Reach, Scope, Tool integration
 - Changing rapidly, expect improvements in coming weeks and months
- The GPO is committed to helping experimenters identify, acquire, & connect the resources they need
 - Email: help@geni.net to get started

- As GENI matures, we expect to enhance those capabilities of greatest use.
 - GENI Racks on dozens, then 100's of campuses
 - OpenFlow deployments on dozens, then 100's of campuses
 - Wireless networks, including WiMax
 - Programmable network devices throughout the network
 - Real users able to directly join (i.e., opt-in) experiments
 - Deep and ubiquitous instrumentation and measurement
- Standard APIs will permit common tools to help with *resource discovery, orchestration, distributed debugging, and experiment management* across a range of technologies

Experiment Planning

- When planning a GENI experiment, consider what kind of resources you need and how they should interconnect
 - Resources (e.g., computation, storage, programmable network devices) are provided by *GENI Aggregates*
- Connectivity between aggregates comes in roughly four flavors
 - L2: Layer 2 (Ethernet VLANs)
 - OF: GPO-engineered OpenFlow Network
(*traffic flowspec &/or programmable switch controller*)
 - IP: GPO-engineered IP
 - Internet

Subject to availability, an experiment can include *any resource in any location using any connectivity*

- Introduction
- Resources
 - Compute & Programmable Systems
 - Wireless
 - Networks
 - Tools
- Getting access
- Wrap-up

Compute Resources in GENI (highlights)

PlanetLab

- Global testbed of user-mode VMs on the Internet
- myPLC: local PlanetLabs often with 'interesting' connectivity options

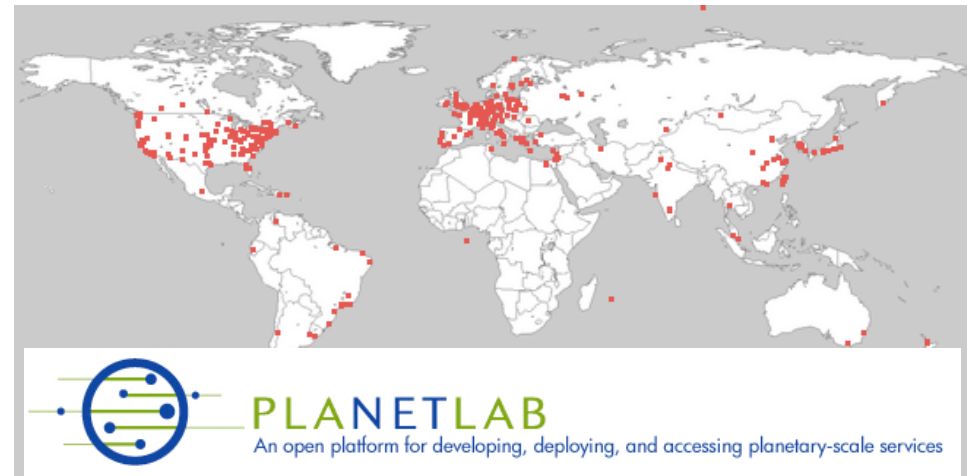

ProtoGENI

- Emulab-based compute clusters
- Experimenters get choice of OS; root access; local topology control
- Rapidly evolving tools for WAN topology control

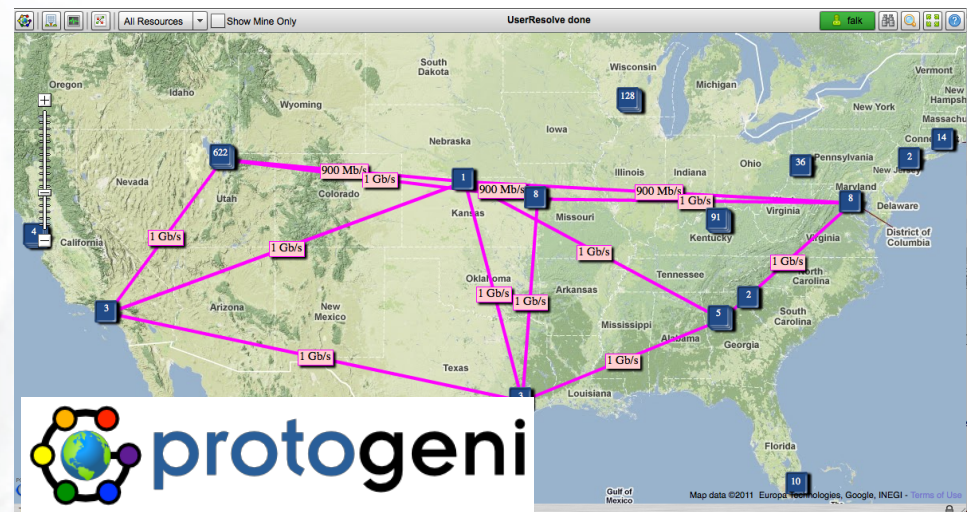



GENI-enabled Compute Nodes: PlanetLab & MyPLC

Aggregate	Count	Location	Avail?	Connectivity			
				Internet	IP	L2	OF
PlanetLab	1000+ nodes at 500+ sites	Global	Y	Y			
MyPLC at BBN	3	Cambridge, MA	Y	Y	Y	Y	Y
MyPLC at Washington	2	Seattle, WA	BE	Y	Y	Y	Y
MyPLC at Stanford	3	Palo Alto, CA	BE	Y	Y	Y	Y
MyPLC at Georgia Tech	2	Atlanta, GA	BE	Y	Y	Y	Y
MyPLC at Clemson	2	Clemson, SC	BE	Y	Y	Y	Y
MyPLC at Indiana Univ.	?	Indianapolis, IN	BE	Y	Y	Y	Y
MyPLC at Wisconsin	2	Madison, WI	BE	Y	Y	Y	Y
MyPLC at Kansas State	6	Manhattan, KS	BE	Y	S	S	S

Availability: Y: supported now; BE: best effort; BP: by permission; S: coming soon





GENI-enabled Compute Nodes: ProtoGENI

Aggregate	Count	Location	Avail?	Connectivity			
				Internet	IP	L2	OF
ProtoGENI cluster: Utah	~600	Salt Lake City, UT	Y	Y	Y	Y	
ProtoGENI cluster: Internet2 backbone	18	LA, Kansas City, Houston, DC, Atlanta	Y	Y	Y	Y	
Wide Area ProtoGENI nodes	10	Clemson, Georgia Tech, Stanford, Rutgers	BE	Y	Y	Y	Y
ProtoGENI cluster: BBN	11	Cambridge, MA	Y	Y	Y	Y	Y
ProtoGENI cluster: UMass-Lowell	8	Lowell, MA	BE	Y	Y	Y	Y
ProtoGENI cluster: Kentucky	26	Lexington, KY	Y	Y	Y	Y	
ProtoGENI cluster: FIU	3	Miami, FL	BE	Y	Y	Y	
ProtoGENI cluster: LONI	2	Baton Rouge, LA	BE	Y	Y	Y	
ProtoGENI cluster: Wisc	38	Madison, WI	BE	Y			

Availability: Y: supported now; BE: best effort; BP: by permission; S: coming soon





Other GENI-enabled Programmable Systems

Aggregate	Count	Location	Avail?	Connectivity			
				Internet	IP	L2	OF
Seattle GENI <i>P2P hosting platform on home/office computers</i>	4000+ installs	U of Washington and volunteer participants	Y	Y			
Supercharged PlanetLab Platform <i>High-speed programmable router</i>	5 nodes	St. Louis, Salt Lake City, Kansas City, DC, Atlanta	Y	Y	Y		
Programmable Edge Node <i>Virtual router</i>	1 node	U of Massachusetts, Lowell	Y	Y	Y	Y	Y
GENI Cloud / Transcloud <i>Distributed Eucalyptus cluster</i>	100 cpus	HP, UCSD, Kaiserslautern, Northwestern	Y	Y	Y	S	
DETER <i>Compute cluster for security research</i>	200 nodes	Los Angeles, CA	BP	Y			
BGP Multiplexer <i>Buffered interface to global routing</i>	4	Wisconsin, GaTech, Princeton, and Clemson	BE	Y			
Data Intensive Cloud <i>Amazon EC2, S3, EBS Services</i>	variable	Via UMass Amherst	BP	Y			

Availability: Y: supported now; BE: best effort; BP: by permission; S: coming soon



- Introduction
- Resources
 - Compute & Programmable Systems
 - **Wireless**
 - Networks
 - Tools
- Getting access
- Wrap-up

GENI Programmable WiMax Base Stations

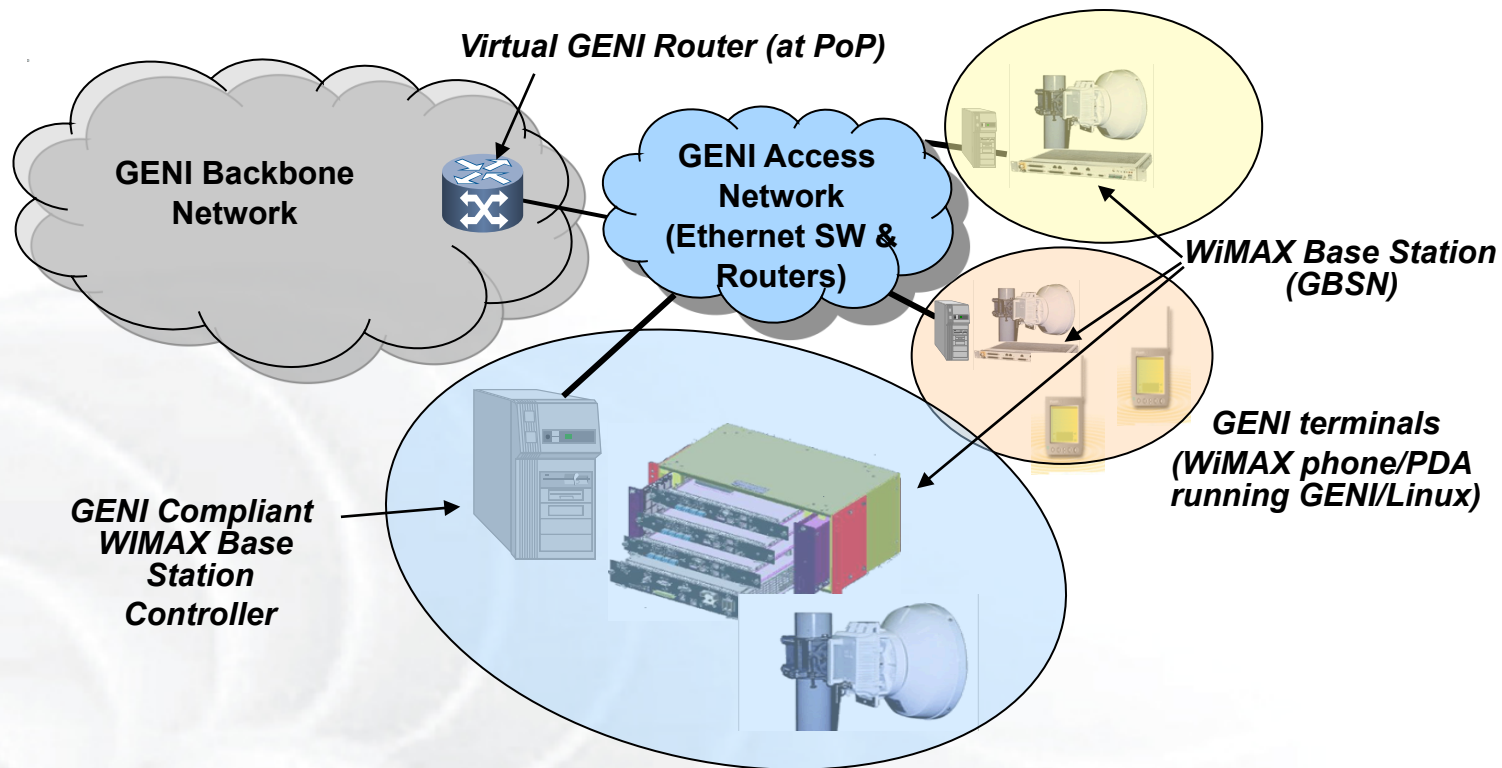

GENI WiMax:

- Commercial IEEE 802.16e WiMAX base station with virtualization & open, programmable interfaces
- Deployed on campuses (4 up now, 4 in deployment)
- Works with commercial clients & handsets
- Good resource for mobility & vehicular experiments

GENI-enabled Wireless Systems (WiMax & others)

Aggregate	Count	Location	Avail?	Connectivity			
				Inter-net	IP	L2	OF
Rutgers WiMax Network	1 base station	New Brunswick, NJ	BP	Y			
BBN WiMax	1 base station	Cambridge, MA	BP	Y	S	S	S
NYU Poly WiMax	1 base station	Brooklyn, NY	S	Y			
UCLA WiMax	1 base station	Los Angeles, CA	S	Y			
ORBIT <i>Large 802.11 Testbed w/ rich tools</i>	400 nodes	New Brunswick, NJ	Y	Y	Y	Y	Y
Kansei <i>Sensor Testbed</i>	96 nodes	Columbus, OH	Y	Y			
CMU Wireless Channel Emulator <i>FPGA-based, Real-time</i>	11 nodes	Pittsburgh, PA	Y	Y			
ViSE <i>Steerable weather radar</i>	3 nodes	Amherst, MA	Y	Y	Y	Y	
DOME <i>VMs on networked city buses</i>	35 nodes	Amherst, MA	Y	Y			

Availability: Y: supported now; BE: best effort; BP: by permission; S: coming soon

- Introduction
- Resources
 - Compute & Programmable Systems
 - Wireless
 - Networks
 - Tools
- Getting access
- Wrap-up

OpenFlow Campus: Stanford GENI Network

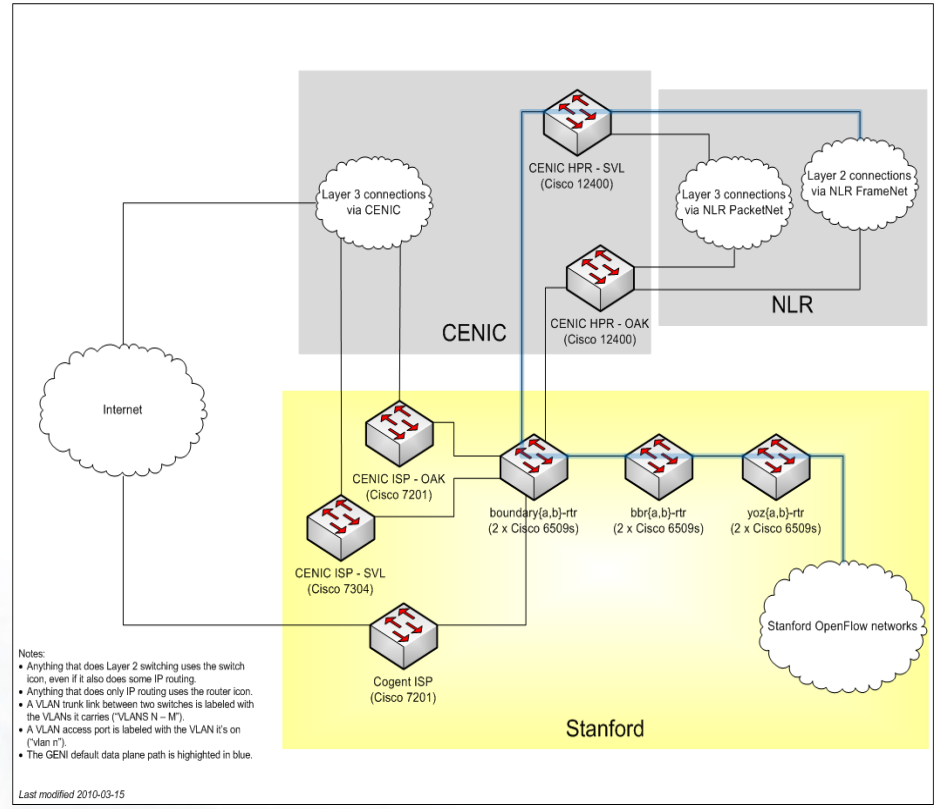
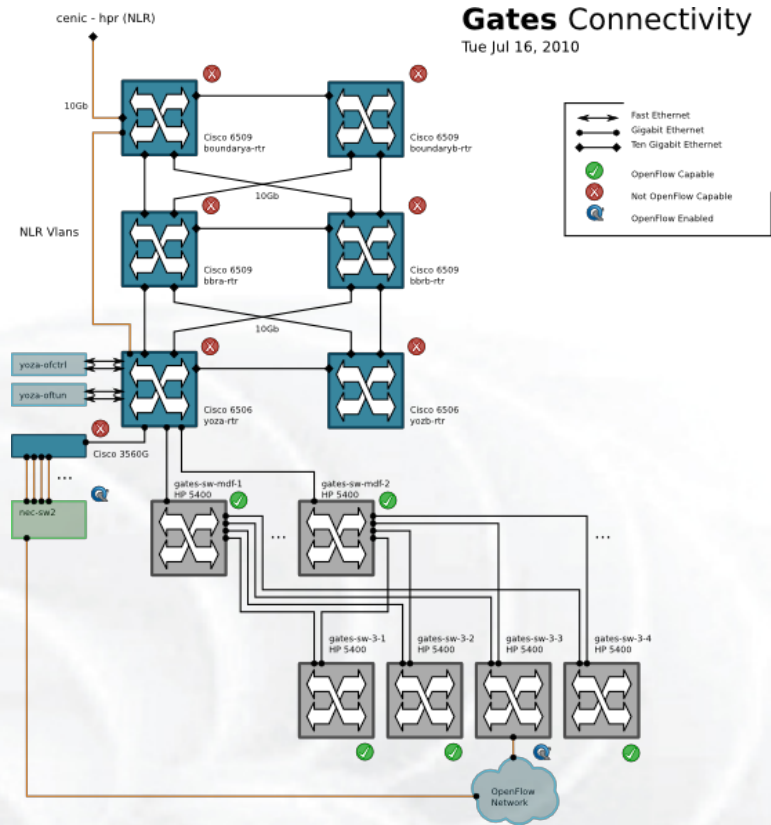

- OpenFlow production traffic **now**
- OpenFlow 1.0 ref implementation **now**
- Early integration with campus trials HP, NEC, Toroki, Quanta, and OpenWRT switches
- OF sw devel/sActiveport

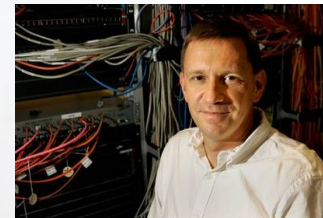

Nick McKeown, PI



Guru Parulkar

GENI-enabled Networks

Many systems mentioned elsewhere also include network resources

Aggregate	Location	Avail?	Connectivity			
			Internet	IP	L2	OF
Internet2 Backbone	LA, Houston, Atlanta, DC, New York	Y	Y	Y	Y	Y
National Lambda Rail Backbone	Seattle, Sunnyvale, Denver, Chicago, Atlanta	Y	Y	Y	Y	Y
Regional Networks	E.g., CENIC, SOX, NOX, BEN, LONI	Y	Y	Y	Y	S
GpENI	Various locations in KS, MO, Europe	Y	Y		S	S
ProtoGENI Internet2 network	LA, Kansas City, Houston, DC, Atlanta	Y	Y	Y	Y	
BBN OpenFlow	Cambridge, MA	Y	Y	Y	Y	Y
Stanford Campus OpenFlow	Palo Alto, CA	Y	Y	Y	Y	Y
U Washington OpenFlow	Seattle, WA		Y	Y	Y	Y
U. Wisconsin OpenFlow	Madison, WI		Y	Y	Y	Y
Indiana OpenFlow	Indianapolis, IN (2 campuses)	Y	Y	Y	Y	Y
Rutgers OpenFlow	New Brunswick, NJ	Y	Y		Y	Y
Clemson Campus OpenFlow	Clemson, SC	Y	Y	Y	Y	Y
Georgia Tech OpenFlow	Atlanta, GA	Y	Y	Y	Y	Y

Availability: Y: supported now; BE: best effort; BP: by permission; S: coming soon

- Introduction
- Resources
 - Compute & Programmable Systems
 - Wireless
 - Networks
 - Tools
- Getting access
- Wrap-up

Gush: Experiment Control Tool

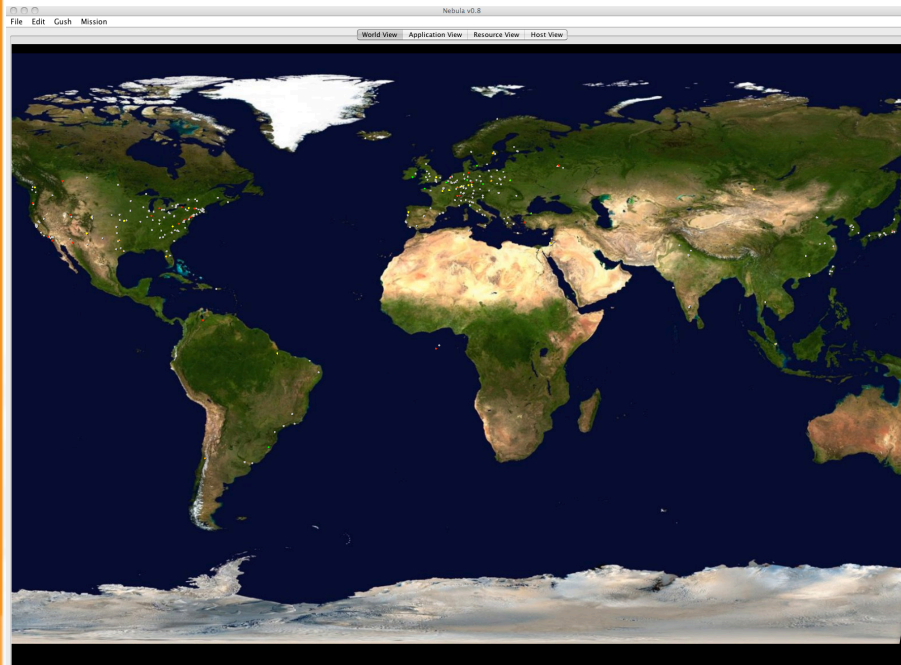

Nebula, a graphical front end to Gush, showing PlanetLab nodes available to an experimenter.

Nebula, a graphical front end to Gush, showing the status of an experiment controlled by Gush.

Gush, a command line based experiment control tool

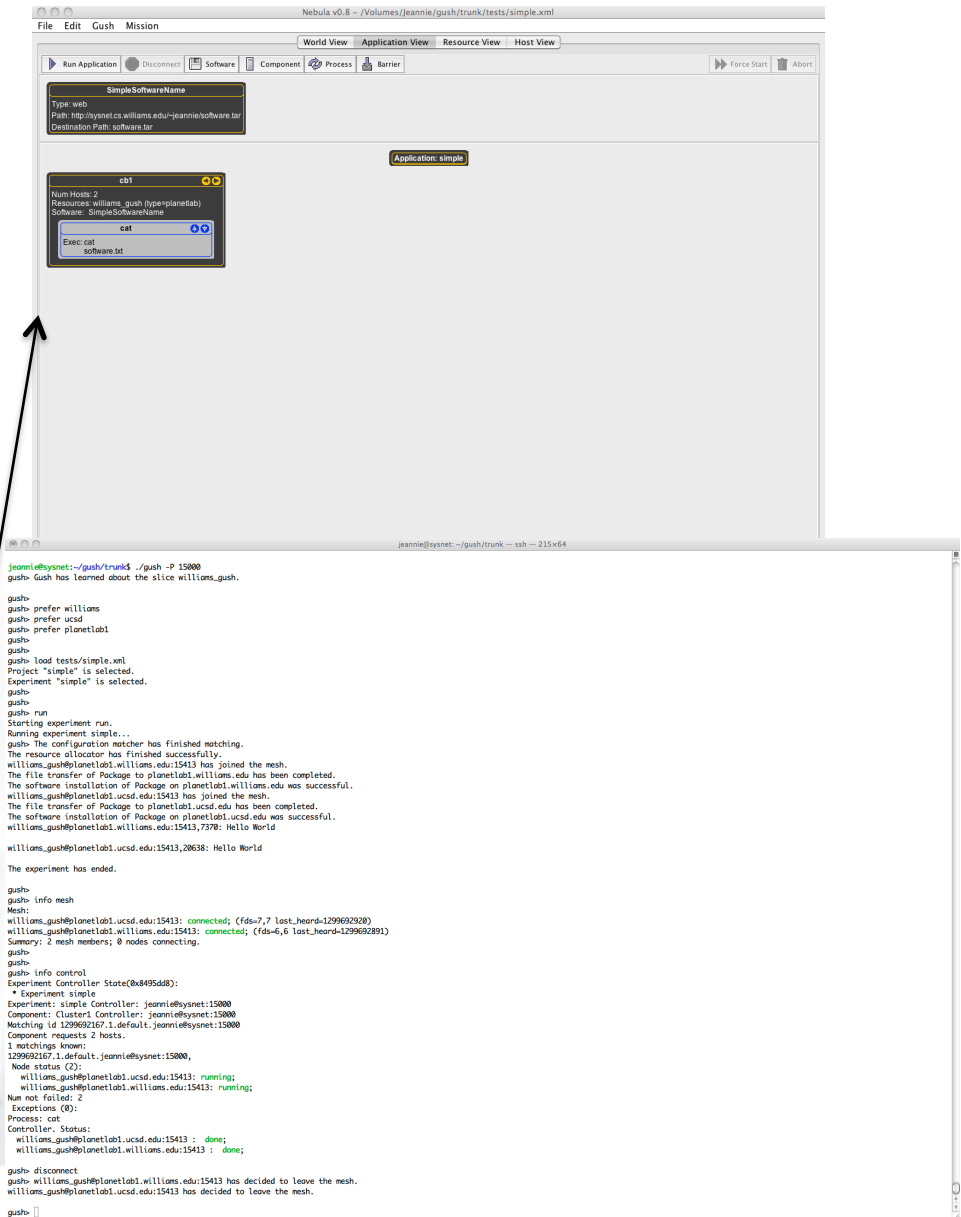

```

jeannie@sysnet:~/gush/trunk$ ./gush -P 15000
gush- Gush has learned about the slice williams_gush.

gush-
gush- prefer williams
gush- prefer ucsd
gush- prefer planetlab1
gush-
gush- load tests/simple.xml
gush- Project "simple" is selected.
gush- Experiment "simple" is selected.
gush-
gush- run
gush- Starting experiment run.
gush- Running experiment simple...
gush- The configuration matcher has finished matching.
gush- The resource allocator has finished successfully.
gush- williams_gush@planetlab1.williams.edu:15413 has joined the mesh.
gush- The file transfer of Package to planetlab1.williams.edu has been completed.
gush- williams_gush@planetlab1.williams.edu:15413 has joined the mesh.
gush- The file transfer of Package to planetlab1.ucsd.edu has been completed.
gush- The software installation of Package on planetlab1.ucsd.edu was successful.
gush- williams_gush@planetlab1.williams.edu:15413,7378: Hello World

williams_gush@planetlab1.ucsd.edu:15413,28638: Hello World

The experiment has ended.

gush-
gush- info mesh
gush- Mesh:
gush- williams_gush@planetlab1.ucsd.edu:15413: connected; (fds=7,7 last_heard=1299692920)
gush- williams_gush@planetlab1.williams.edu:15413: connected; (fds=6,6 last_heard=1299692891)
gush- Summary: 2 mesh members; 0 nodes connecting.
gush-
gush- info control
gush- Experiment Controller State(8d495d48):
gush- * Experiment simple
gush- Experiment: simple Controller: jeannie@sysnet:15000
gush- Component: Cluster1 Controller: jeannie@sysnet:15000
gush- Matching id 1299692167.1.default:jeannie@sysnet:15000
gush- Component requests 2 hosts.
gush- 1 matchings known:
gush- 1299692167.1.default, jeannie@sysnet:15000,
gush- Node status (2):
gush- williams_gush@planetlab1.ucsd.edu:15413: running;
gush- williams_gush@planetlab1.williams.edu:15413: running;
gush- Num not failed: 2
gush- Exceptions (0):
gush- Process: cat
gush- Controller: Status:
gush- williams_gush@planetlab1.ucsd.edu:15413 : done;
gush- williams_gush@planetlab1.williams.edu:15413 : done;

gush- disconnect
gush- williams_gush@planetlab1.williams.edu:15413 has decided to leave the mesh.
gush- williams_gush@planetlab1.ucsd.edu:15413 has decided to leave the mesh.

gush-
  
```

ProtoGENI Map Client

ProtoGENI Map Client showing resources available through the ProtoGENI clearinghouse

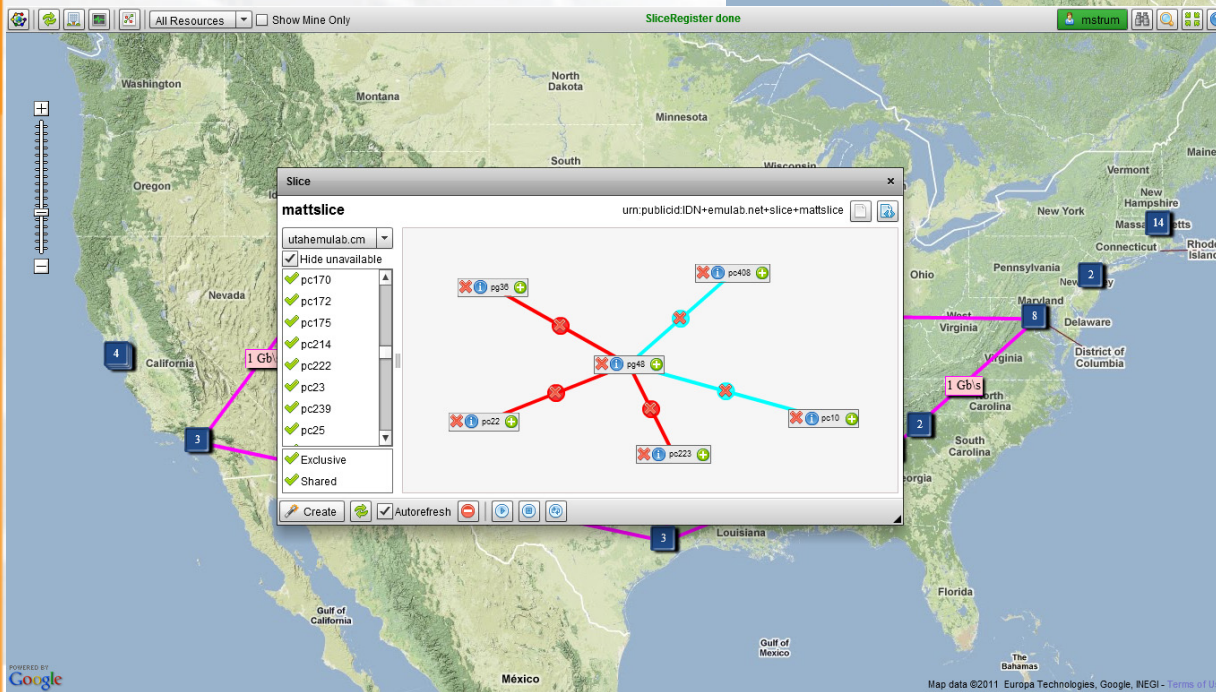
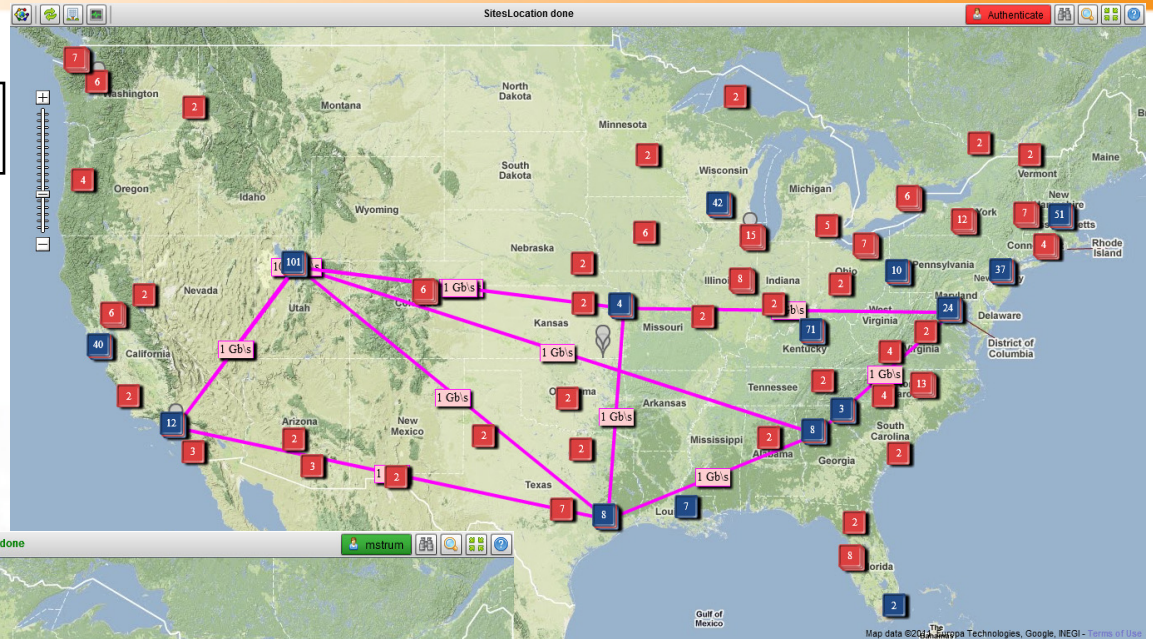

ProtoGENI Map Client showing a slice being created with resources from three aggregates

Kentucky Instrumentation Tool

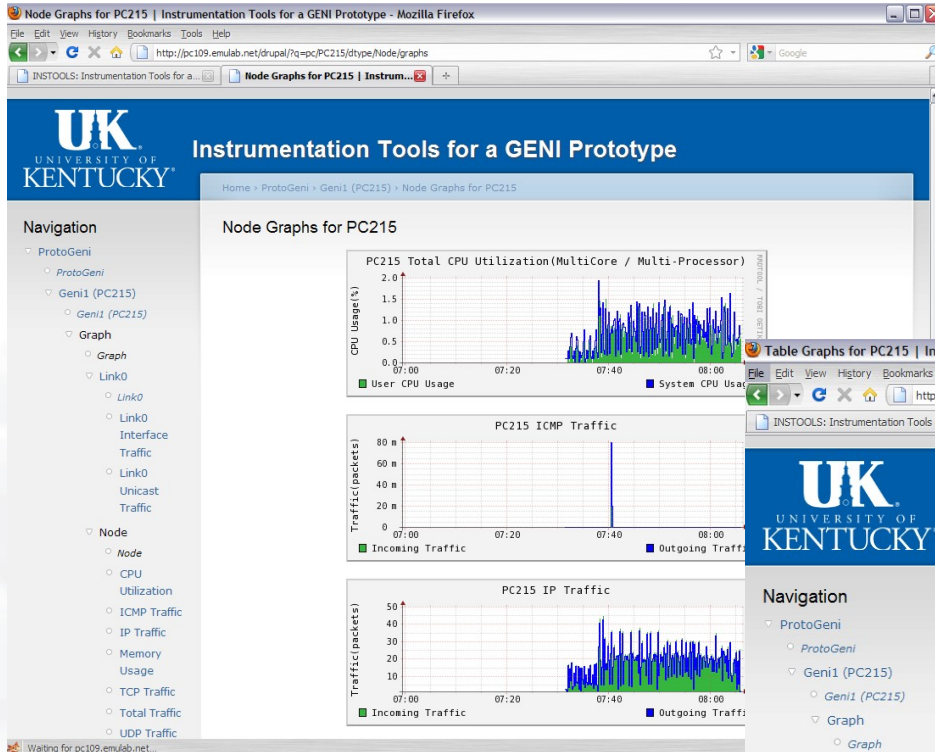
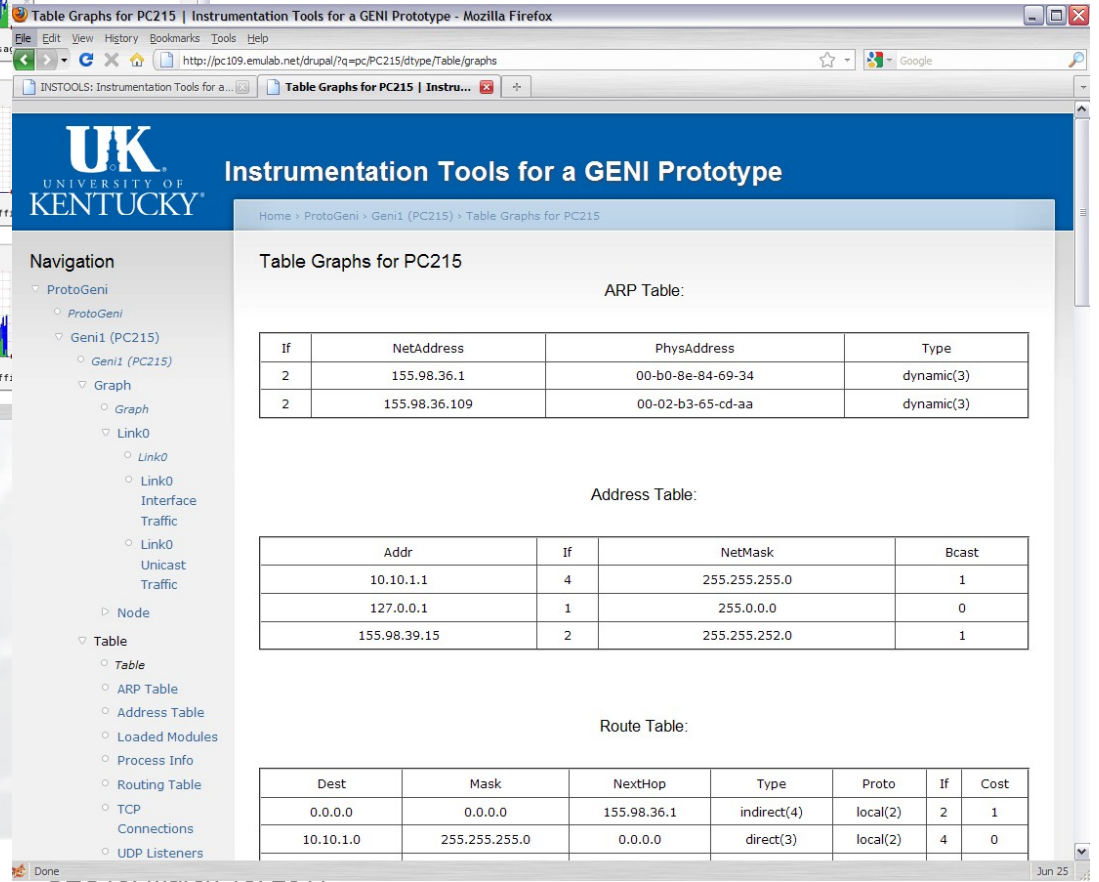



Table Graphs for PC215

Navigation

- ProtoGeni
 - Geni1 (PC215)
 - Graph
 - Link0
 - Interface Traffic
 - Link0 Unicast Traffic
 - Node
 - CPU Utilization
 - ICMP Traffic
 - IP Traffic
 - Memory Usage
 - TCP Traffic
 - Total Traffic
 - UDP Traffic
 - Table
 - ARP Table
 - Address Table
 - Loaded Modules
 - Process Info
 - Routing Table
 - TCP Connections
 - UDP Listeners

ARP Table:

If	NetAddress	PhysAddress	Type
2	155.98.36.1	00-b0-8e-84-69-34	dynamic(3)
2	155.98.36.109	00-02-b3-65-cd-aa	dynamic(3)

Address Table:

Addr	If	NetMask	Bcast
10.10.1.1	4	255.255.255.0	1
127.0.0.1	1	255.0.0.0	0
155.98.39.15	2	255.255.252.0	1

Route Table:

Dest	Mask	NextHop	Type	Proto	If	Cost
0.0.0.0	0.0.0.0	155.98.36.1	indirect(4)	local(2)	2	1
10.10.1.0	255.255.255.0	0.0.0.0	direct(3)	local(2)	4	0

Two different views of experiment data collected and analyzed using the Kentucky instrumentation tool.

Raven: Distributed System Provisioning and Management

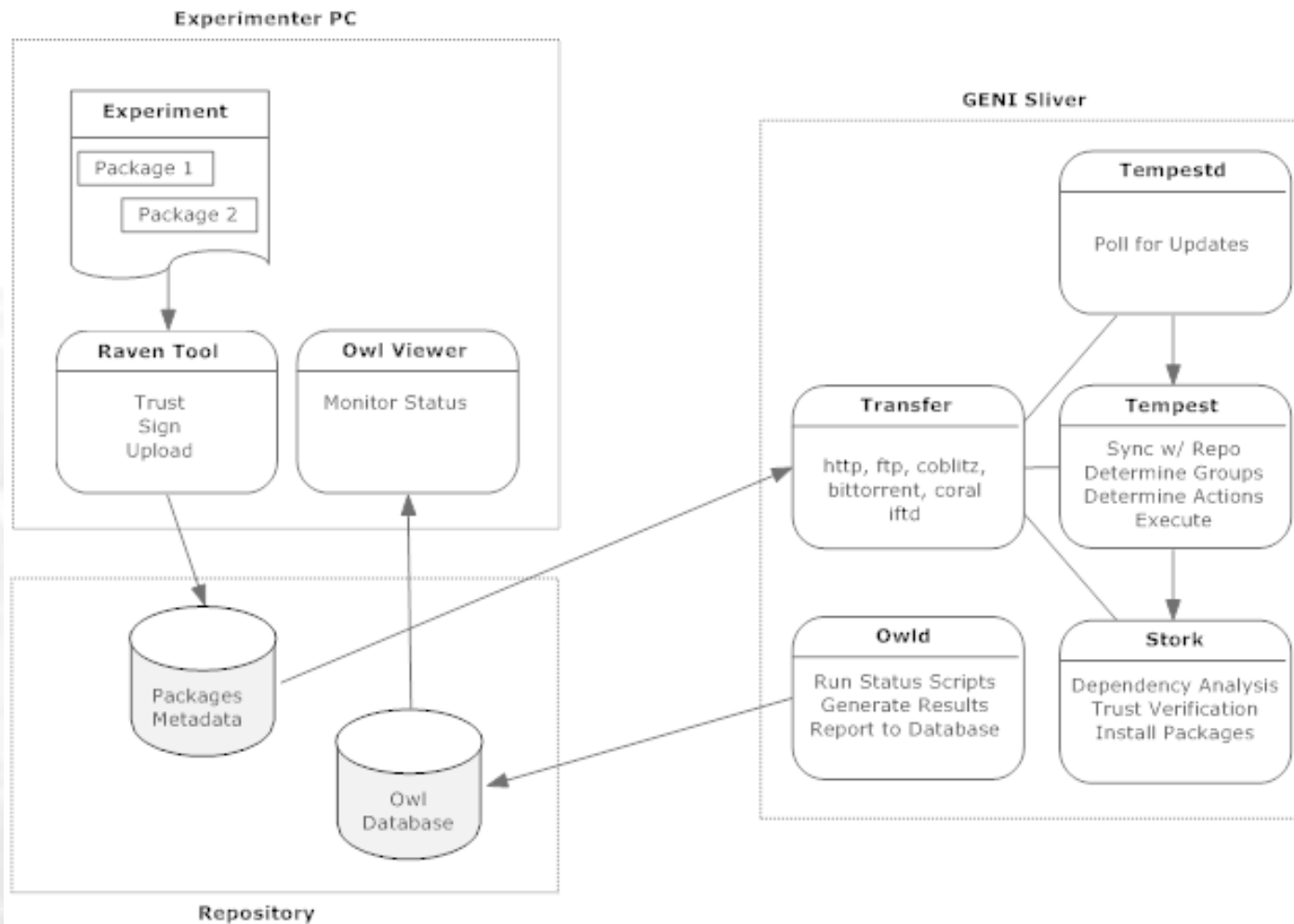

The Raven suite of tools provide software package management and monitoring for large, long-running experiments

ORBIT Management Framework (OMF): Experiment Deployment, Control, Mgmt

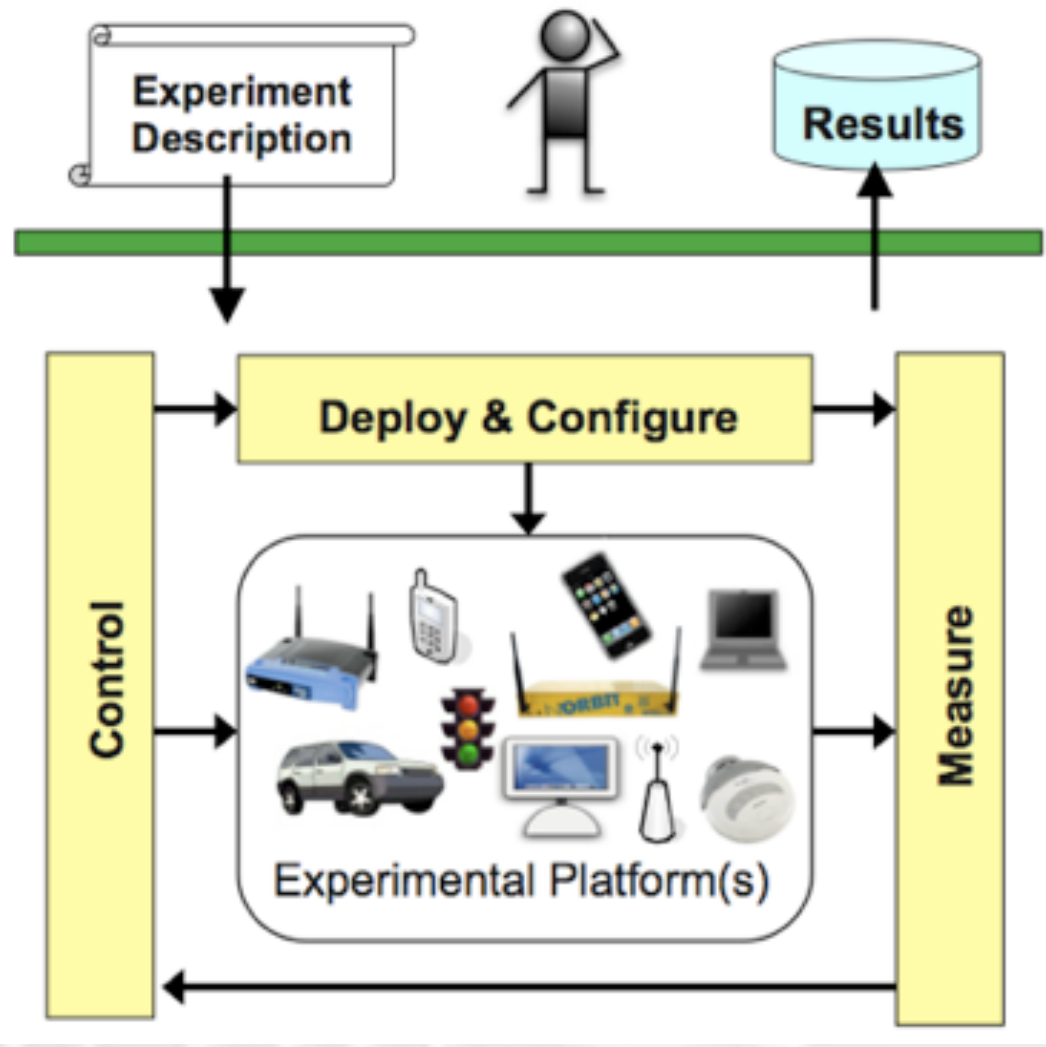

Two OMF suite of tools support experiment deployment, control and measurement.

GENI Experimenter Tools

Resource	Description	Avail?	Works with...
OMNI	Resource acquisition	Y	PlanetLab, ProtoGENI, OpenFlow, myPLC
sfi	Resource acquisition	Y	PlanetLab, MyPLC
ProtoGENI Tools	Enhanced resource orchestration & topology tools	Y	ProtoGENI
ORCA	Resource acquisition	BE	DiCloud, ViSE, DOME, Kansei.
Seattle GENI Tools	Allows Seattle GENI to integrate with ProtoGENI systems	Y	Seattle GENI
GUSH	Experiment control and management	Y	PlanetLab, MyPLC, ProtoGENI
Raven	Distributed system provisioning & management tools	Y	PlanetLab
NOX	Customizable switch controller	Y	OpenFlow capable Ethernet switches
Expedient	GUI for provisioning OpenFlow & myPLC	BE	Some OpenFlow campuses, some myPLC
LAMP	perSONAR instrumentation that runs within an experiment	Y	ProtoGENI
OMF/OML	Measurement tools & experiment control framework	Y	ORBIT, WiMax
Instrumentation Tools	Host and network measurement and monitoring	Y	Univ. Kentucky ProtoGENI cluster
On-Time Measurement	Orchestration & provisioning of active measurements within an experiment	BE	ProtoGENI

Availability: Y: supported now; BE: best effort; BP: by permission; S: coming soon

- Introduction
- Resources
 - Compute & Programmable Systems
 - Wireless
 - Networks
 - Tools
- Getting access
- Wrap-up

- In general, any researcher can gain access to any GENI resource
- Access control typically requires first **getting an account** where you provide some information about you and your plans then **acquiring resources** where you ask for what you want
 - Access control mechanisms vary, but are consolidating
 - Details at <http://groups.geni.net/geni/wiki/ExperimenterPortal>

Let us help: email help@geni.net

- Introduction
- Resources
 - Compute & Programmable Systems
 - Wireless
 - Networks
 - Tools
- Getting access
- Wrap-up

- GENI Racks
 - Notionally: rack of ~40 computers & programmable switch, connected to a GENI backbone
 - Next 2-3 years: 20-40 racks in campuses, industrial research labs, topologically significant locations
- Real users
 - Notionally: Enable campus networks to allow students, faculty, & staff to directly join (opt-in) in GENI experiments
 - Next 2-3 years: OpenFlow and WiMax deployments on 10-20 campuses enable direct-to-end-system experiments



GENI Racks



Opt-In Users

GENI's vision: expand reach to 100-200 campuses

- Resource listing:
 - <http://groups.geni.net/geni/wiki/ExperimenterPortal>
- Connectivity Guide:
 - <http://groups.geni.net/geni/wiki/ConnectivityOverview>
- Advice & assistance:
 - help@geni.net